



Features :

- Isolated mounting base 2500V~
- Pressure contact technology with Increased power cycling capability
- Space and weight saving

Typical Applications :

- AC/DC Motor drives
- Various rectifiers
- DC supply for PWM inverter

V _{DSM} ,V _{RSM}	V _{DRM} ,V _{RRM}	Type & Outline
900V	800V	MTx1000-08-411F3
1100V	1000V	MTx1000-10-411F3
1300V	1200V	MTx1000-12-411F3
1500V	1400V	MTx1000-14-411F3
1700V	1600V	MTx1000-16-411F3
1900V	1800V	MTx1000-18-411F3

SYMBOL	CHARACTERISTIC	TEST CONDITIONS	T _j (°C)	VALUE			UNIT
				Min	Type	Max	
I _{T(AV)}	Mean on-state current	180° half sine wave 50Hz Single side cooled,T _c =55°C	125			1000	A
I _{T(RMS)}	RMS on-state current					1570	A
I _{DRM} I _{RRM}	Repetitive peak current	at V _{DRM} at V _{RRM}	125			55	mA
I _{TSM}	Surge on-state current	10ms half sine wave, V _R =0.6V _{RRM}	125			26.0	kA
I ² t	I ² t for fusing coordination					3380	A ² s*10 ³
V _{TO}	Threshold voltage		125			0.81	V
r _T	On-state slope resistance					0.21	mΩ
V _{TM}	Peak on-state voltage	I _{TM} =3000A	25			2.05	V
dv/dt	Critical rate of rise of off-state voltage	V _{DM} =67%V _{DRM}	125			800	V/μs
di/dt	Critical rate of rise of on-state current	Gate source 1.5A t _r ≤ 0.5μs Repetitive	125			100	A/μs
I _{GT}	Gate trigger current	V _A =12V, I _A =1A	25	30		200	mA
V _{GT}	Gate trigger voltage			0.8		3.0	V
I _H	Holding current			10		200	mA
V _{GD}	Non-trigger gate voltage	V _{DM} =67%V _{DRM}	125	0.2			V
R _{th(j-c)}	Thermal resistance Junction to case	Single side cooled per chip				0.052	°C /W
R _{th(c-h)}	Thermal resistance case to heat sink	Single side cooled per chip				0.018	°C /W
V _{iso}	Isolation voltage	50Hz,R.M.S.,t=1min,I _{iso} :1mA(MAX)		2500			V
F _m	Terminal connection torque(M12)				14.0		N·m
	Mounting torque(M8)				12.0		N·m
T _{vj}	Junction temperature			-40		125	°C
T _{stg}	Stored temperature			-40		125	°C
W _t	Weight				3460		g
Outline	411F3						

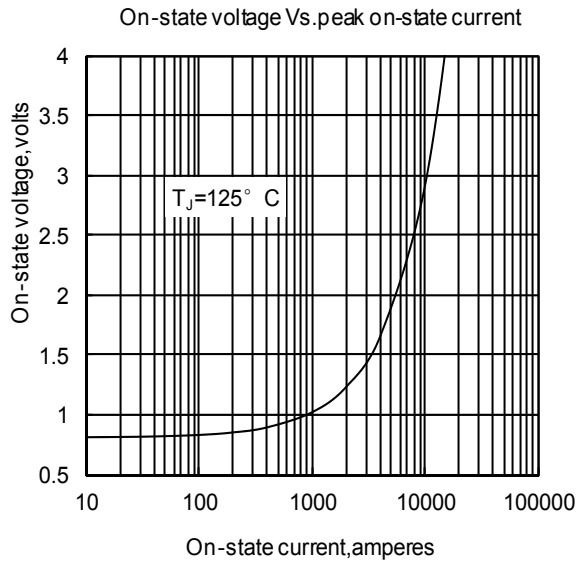

Fig1

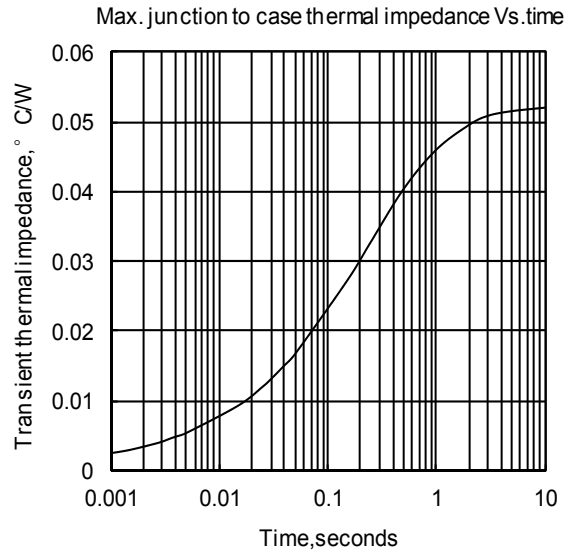

Fig2

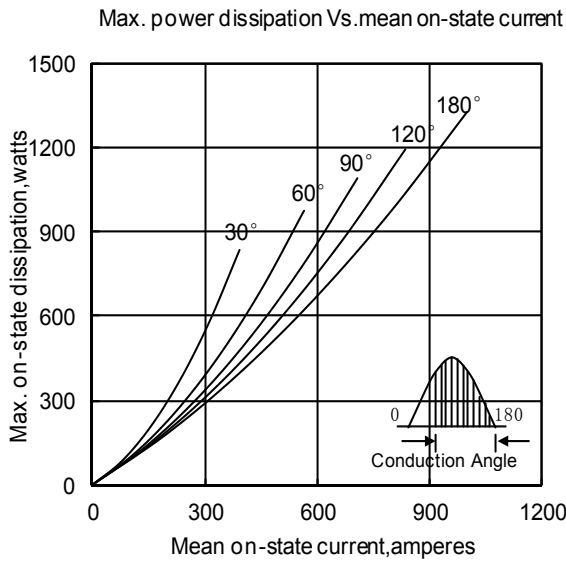

Fig3

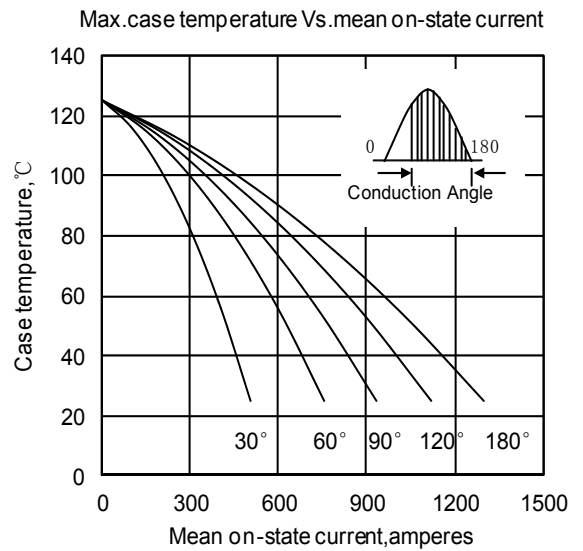

Fig4

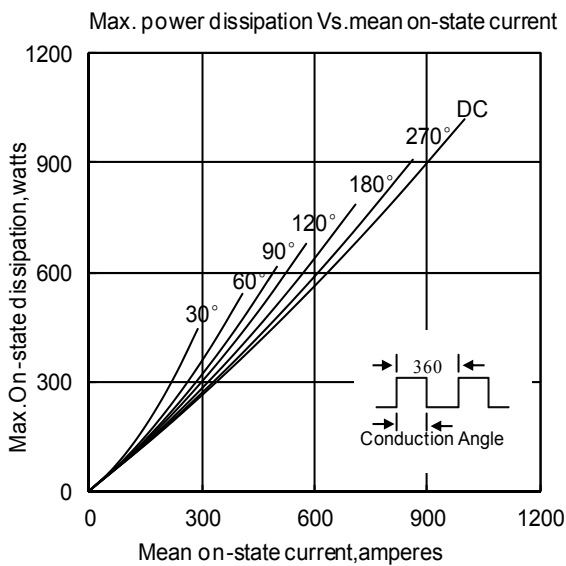

Fig5

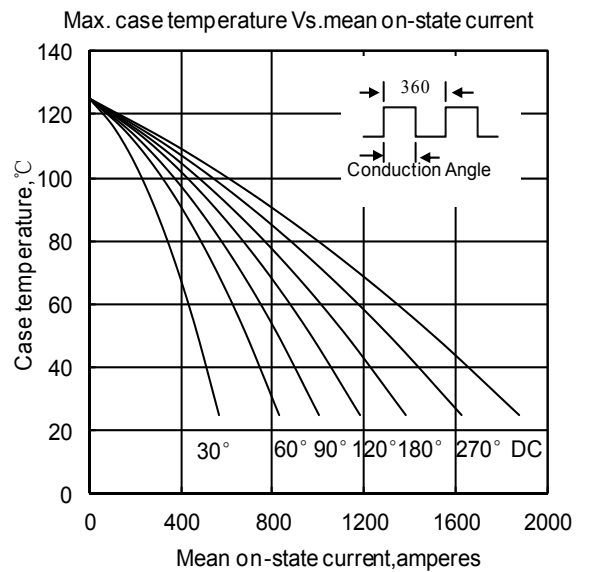

Fig6

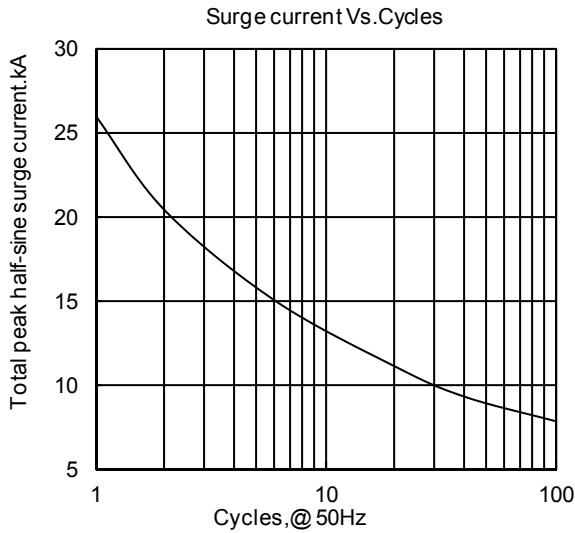

Fig7

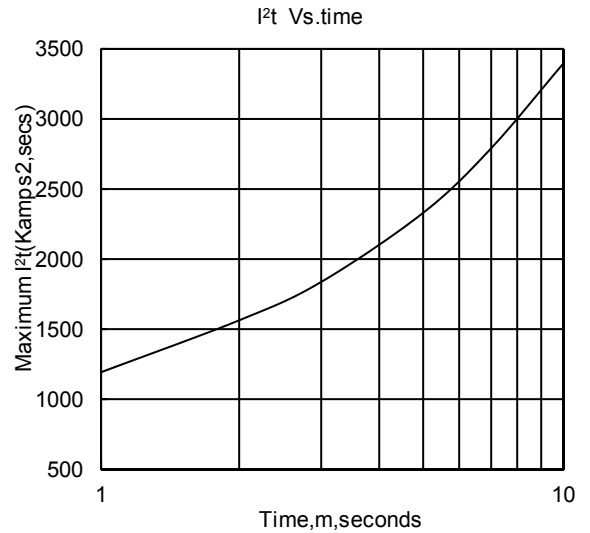

Fig8

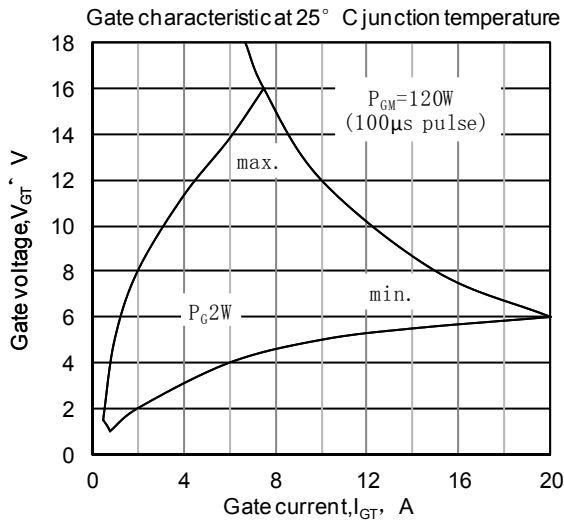

Fig9

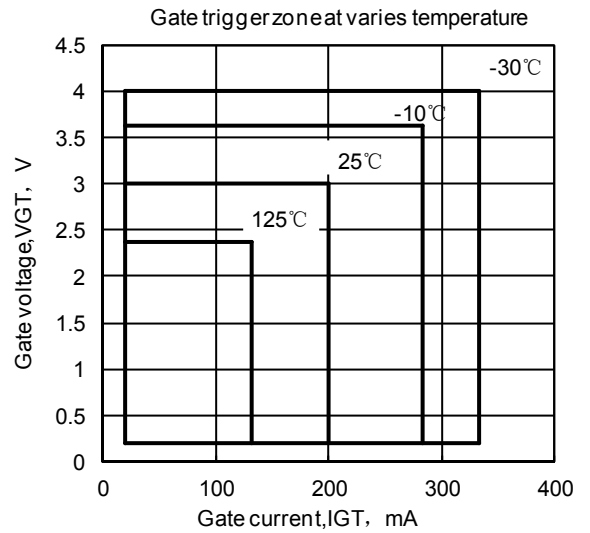
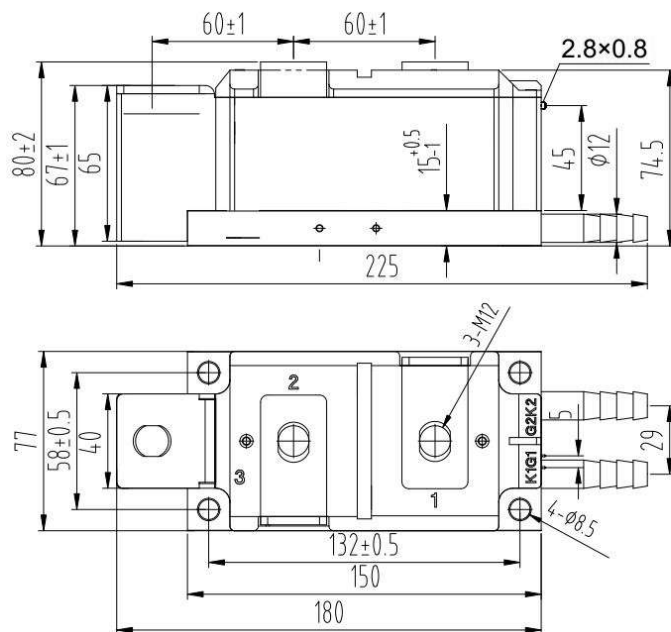
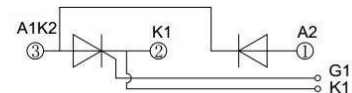

Fig10

Outline:



MFC (TD)



MFA (TD)

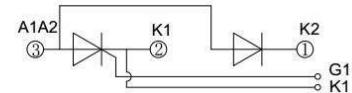

MFK (TD)

