

Features :

- Isolated mounting base 4000V~
- Pressure contact technology with Increased power cycling capability
- Space and weight saving

Typical Applications

- Various rectifiers
- DC supply for PWM inverter

V_{RSM}	V_{RRM}	Type & Outline
2700V	2600V	MDx110-26-216F3
2900V	2800V	MDx110-28-216F3
3100V	3000V	MDx110-30-216F3
3300V	3200V	MDx110-32-216F3
3500V	3400V	MDx110-34-216F3
3700V	3600V	MDx110-36-216F3

SYMBOL	CHARACTERISTIC	TEST CONDITIONS	$T_j(^{\circ}C)$	VALUE			UNIT
				Min	Type	Max	
$I_{F(AV)}$	Mean forward current	180° half sine wave 50Hz Single side cooled, $T_c=100^{\circ}C$	150			110	A
$I_{F(RMS)}$	RMS forward current		150			173	A
I_{RRM}	Repetitive peak current	at V_{RRM}	150			20	mA
I_{FSM}	Surge forward current	10ms half sine wave $V_R=0.6V_{RRM}$	150			2.10	kA
I^2t	I^2t for fusing coordination					22	$A^2s \cdot 10^3$
V_{FO}	Threshold voltage		150			0.95	V
r_F	Forward slope resistance					1.76	mΩ
V_{FM}	Peak forward voltage	$I_{FM}=330A$	25			2.25	V
$R_{th(j-c)}$	Thermal resistance Junction to case	At 180° sine Single side cooled per chip				0.31	$^{\circ}C/W$
$R_{th(c-h)}$	Thermal resistance case to heatsink	At 180° sine Single side cooled per chip				0.08	$^{\circ}C/W$
V_{iso}	Isolation voltage	50Hz, R.M.S, $t=1min$, $I_{iso}=1mA(max)$		4000			V
F_m	Terminal connection torque(M6)				6.0		N·m
	Mounting torque(M6)				6.0		N·m
T_{stg}	Stored temperature			-40		125	$^{\circ}C$
W_t	Weight				320		g
Outline	216F3						

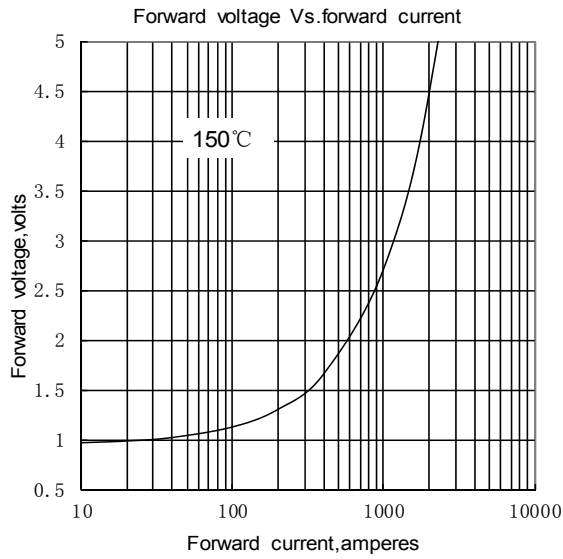

Fig.1

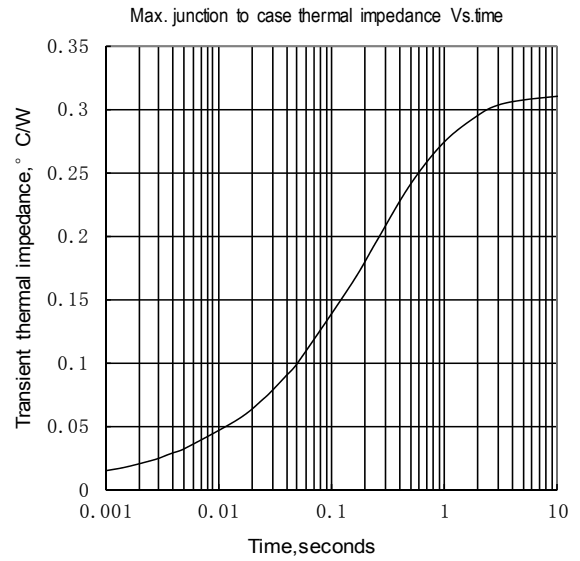

Fig.2

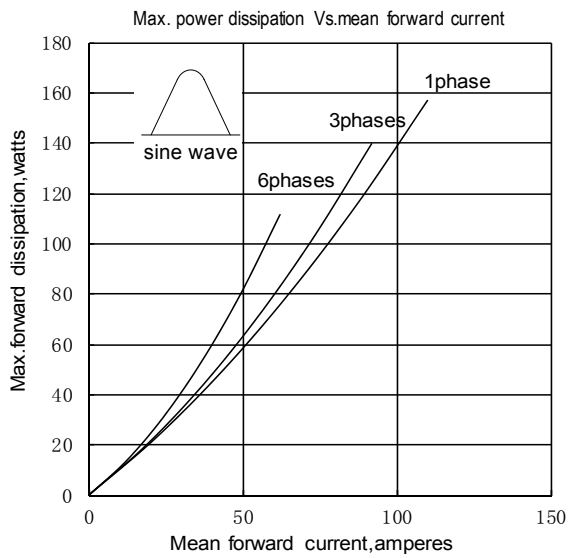

Fig.3

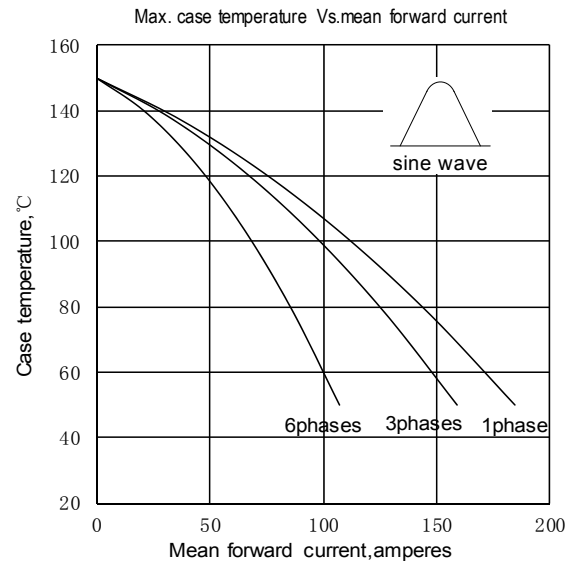

Fig.4

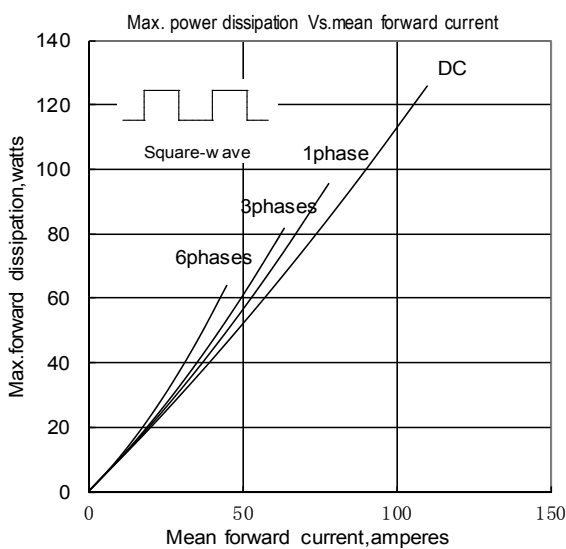

Fig.5

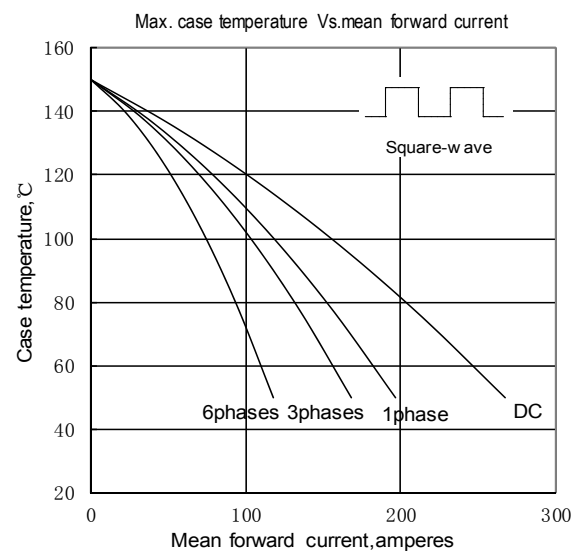

Fig.6

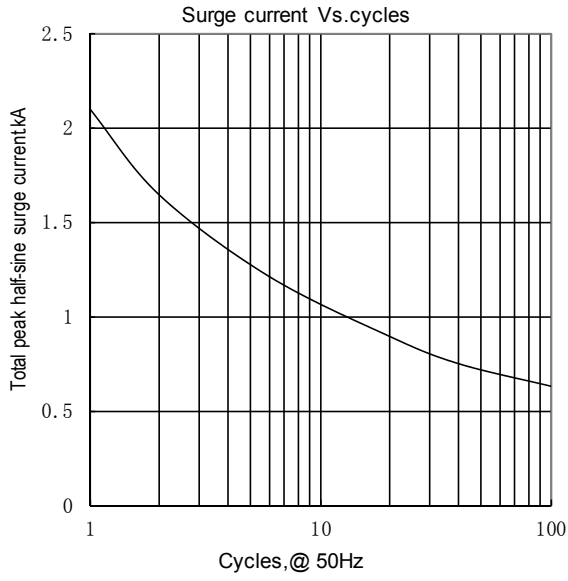

Fig.7

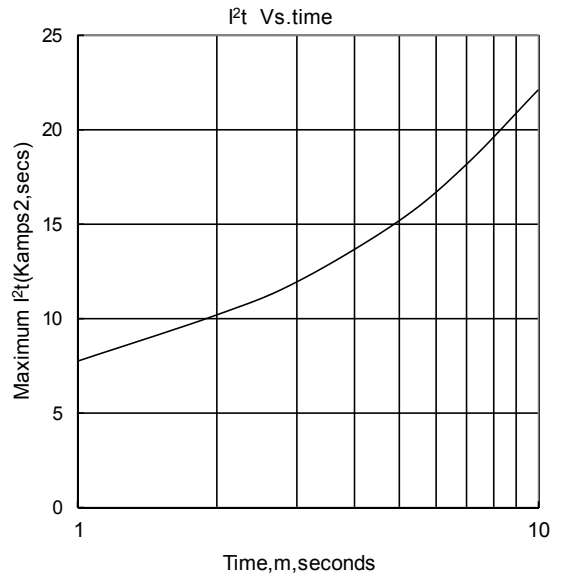
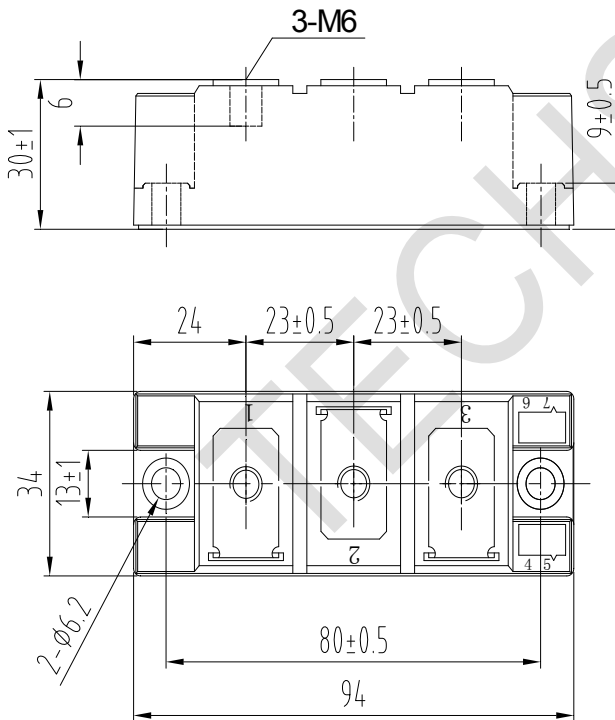
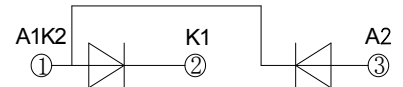

Fig.8

Outline:



MDC



MDA

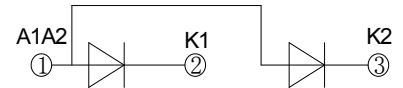

MDK

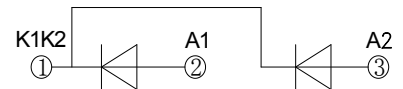

MD

