

**Features:**

- Isolated mounting base 3000V~
- Pressure contact technology with Increased power cycling capability
- Space and weight saving

**Typical Applications**

- Various rectifiers
- DC supply for PWM inverter

$V_{RSM}$	$V_{RRM}$	Type & Outline
2100V	2000V	MDx1000-20-412F3
2300V	2200V	MDx1000-22-412F3
2600V	2500V	MDx1000-25-412F3

SYMBOL	CHARACTERISTIC	TEST CONDITIONS	$T_j(^{\circ}C)$	VALUE			UNIT
				Min	Type	Max	
$I_{F(AV)}$	Mean forward current	180° half sine wave 50Hz	150			1000	A
$I_{F(RMS)}$	RMS forward current	Single side cooled, $T_c=100^{\circ}C$	150			1570	A
$I_{RRM}$	Repetitive peak current	at $V_{RRM}$	150			50	mA
$I_{FSM}$	Surge forward current	10ms half sine wave	150			26	kA
$I^2t$	$I^2t$ for fusing coordination	$V_R=0.6V_{RRM}$				3380	$A^2s \cdot 10^3$
$V_{FO}$	Threshold voltage		150			0.71	V
$r_F$	Forward slope resistance					0.10	m $\Omega$
$V_{FM}$	Peak forward voltage	$I_{FM}=3000A$	25			1.85	V
$R_{th(j-c)}$	Thermal resistance Junction to case	At 180° sine Single side cooled per chip				0.052	$^{\circ}C/W$
$R_{th(c-h)}$	Thermal resistance case to heatsink	At 180° sine Single side cooled per chip				0.020	$^{\circ}C/W$
$V_{iso}$	Isolation voltage	50Hz, R.M.S, t=1min, $I_{iso}: 1mA(max)$		3000			V
$F_m$	Terminal connection torque(M12)				14.0		N·m
	Mounting torque(M8)				12.0		N·m
$T_{stg}$	Stored temperature			-40		125	$^{\circ}C$
$W_t$	Weight				3660		g
Outline	412F3						

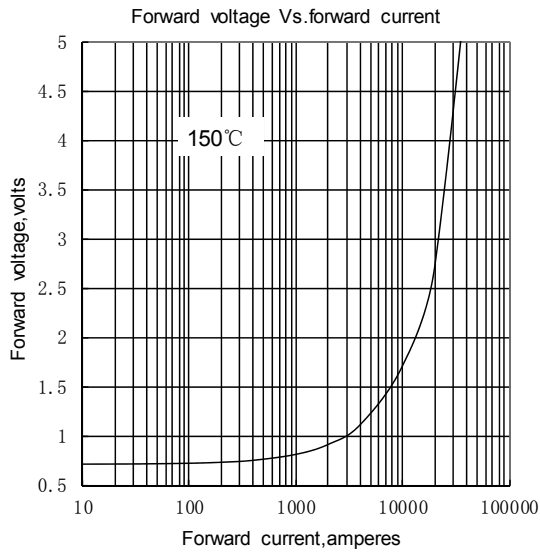

Fig.1

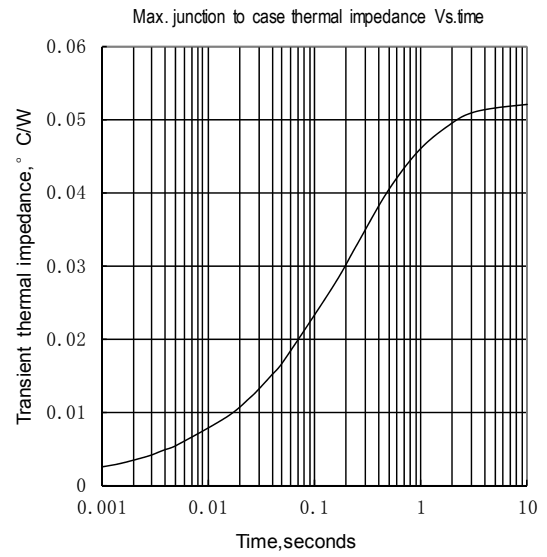

Fig.2

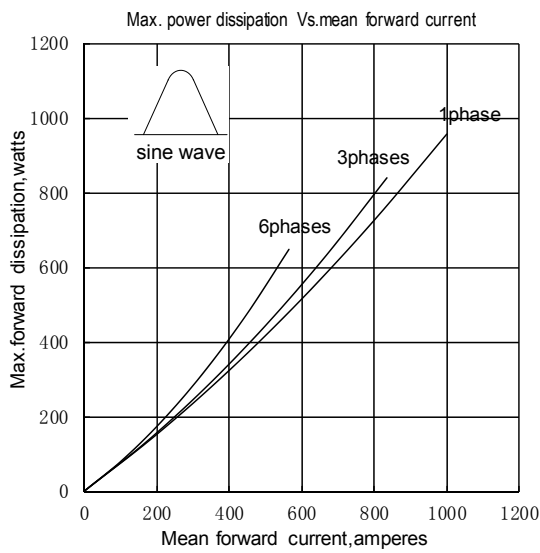

Fig.3

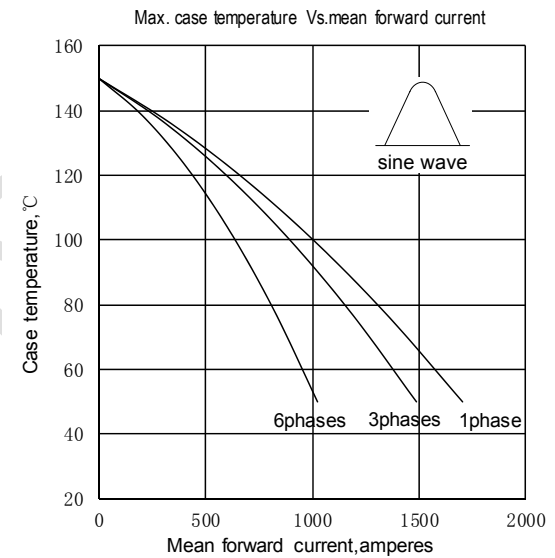

Fig.4

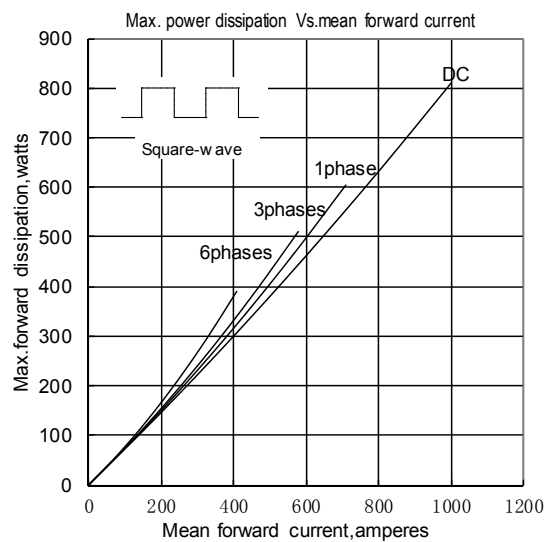

Fig.5

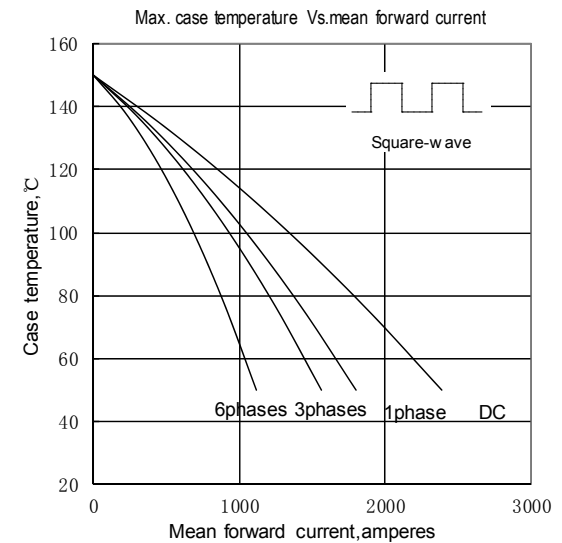

Fig.6

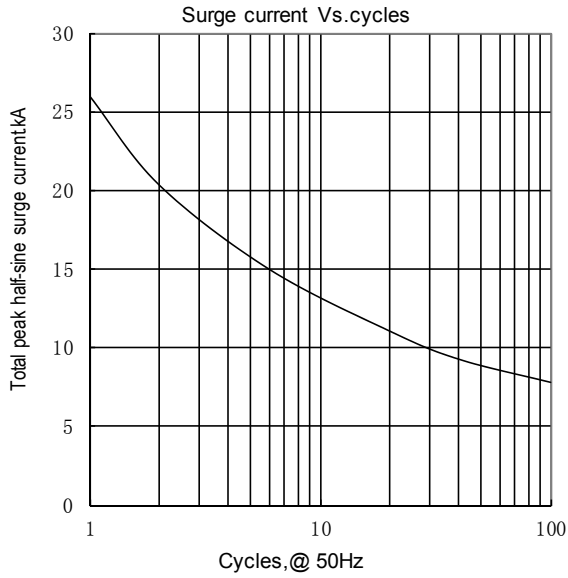

Fig.7

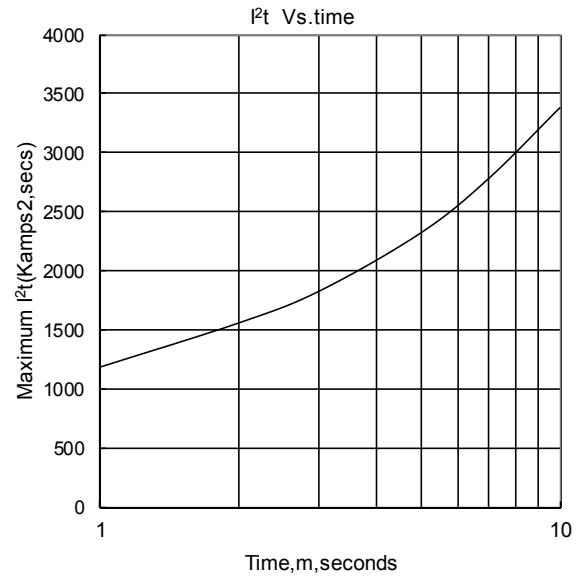
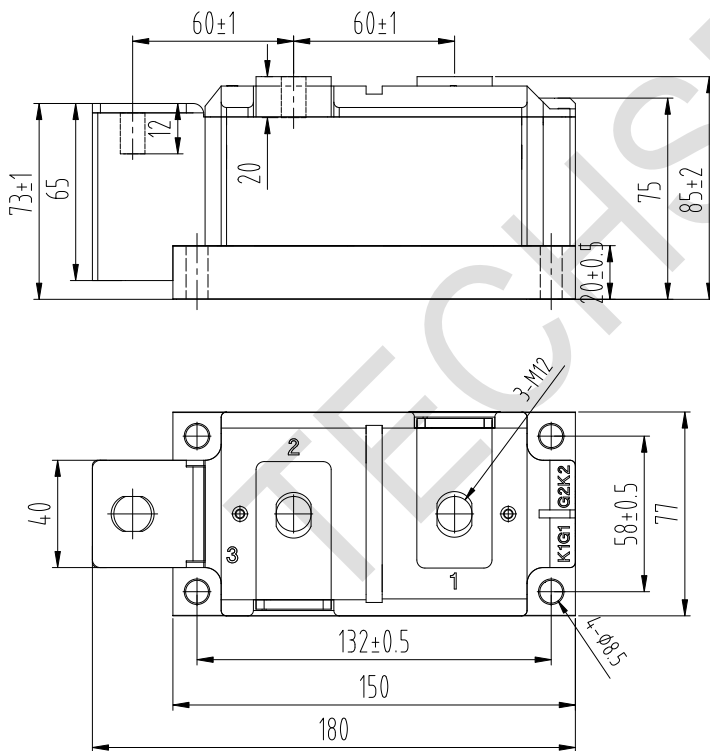
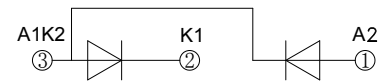

Fig.8

Outline:



MDC



MDA

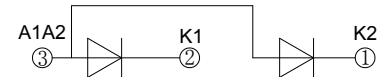

MDK

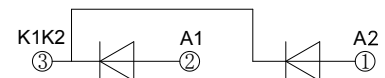

MD

