**Features:**

- Isolated mounting base 3000V~
- Pressure contact technology with increased power cycling capability
- Space and weight saving

Typical Applications

- Various rectifiers
- DC supply for PWM inverter

V_{RSM}	V_{RRM}	Type & Outline
2100V	2000V	MDx200-20-216F3
2300V	2200V	MDx200-22-216F3
2600V	2500V	MDx200-25-216F3

SYMBOL	CHARACTERISTIC	TEST CONDITIONS	$T_j(^{\circ}C)$	VALUE			UNIT
				Min	Type	Max	
$I_{F(AV)}$	Mean forward current	180° half sine wave 50Hz Single side cooled, $T_c=100^{\circ}C$	150			200	A
$I_{F(RMS)}$	RMS forward current		150			314	A
I_{RRM}	Repetitive peak current	at V_{RRM}	150			12	mA
I_{FSM}	Surge forward current	10ms half sine wave $V_R=0.6V_{RRM}$	150			7.1	kA
I^2t	I^2t for fusing coordination					252	$A^2s \cdot 10^3$
V_{FO}	Threshold voltage		150			0.82	V
r_F	Forward slope resistance					0.96	m Ω
V_{FM}	Peak forward voltage	$I_{FM}=600A$	25			1.48	V
$R_{th(j-c)}$	Thermal resistance Junction to case	At 180° sine Single side cooled per chip				0.18	$^{\circ}C/W$
$R_{th(c-h)}$	Thermal resistance case to heatsink	At 180° sine Single side cooled per chip				0.08	$^{\circ}C/W$
V_{iso}	Isolation voltage	50Hz, R.M.S, $t=1min, I_{iso}: 1mA(max)$		3000			V
F_m	Terminal connection torque(M6)				6.0		N·m
	Mounting torque(M6)				6.0		N·m
T_{stg}	Stored temperature			-40		125	$^{\circ}C$
W_t	Weight				285		g
Outline	216F3						

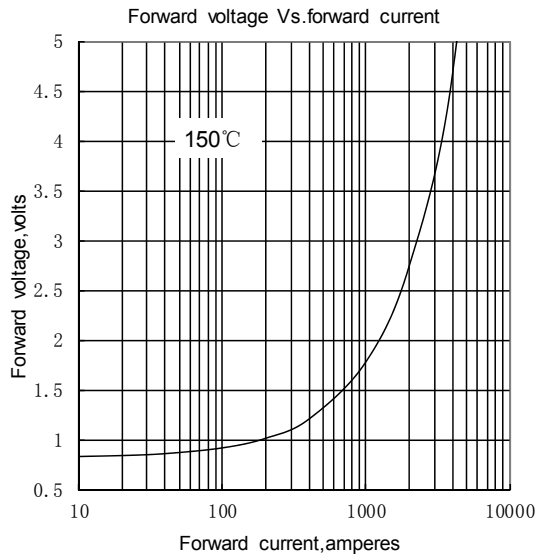

Fig.1

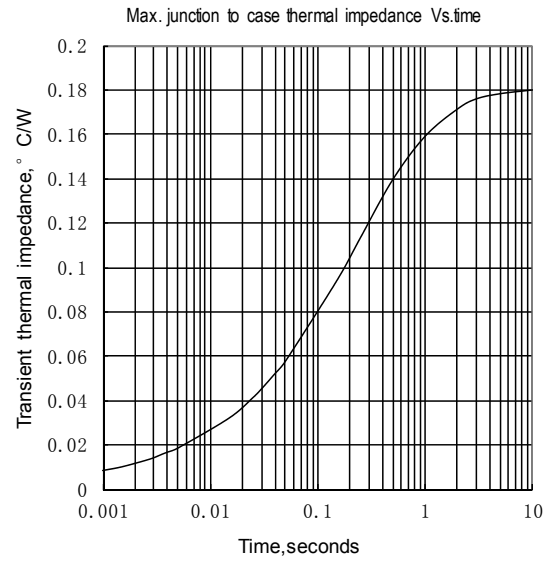

Fig.2

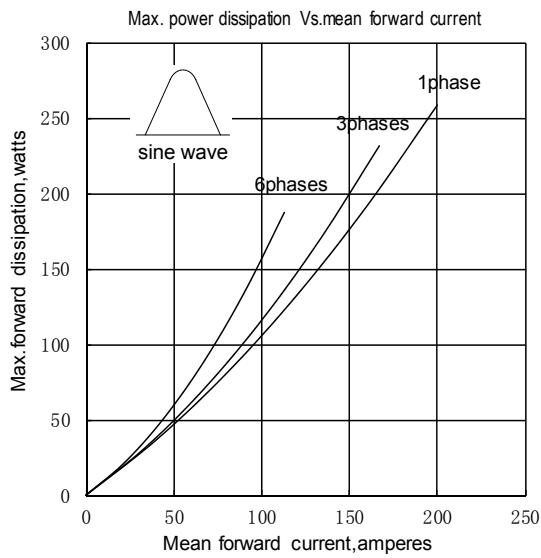

Fig.3

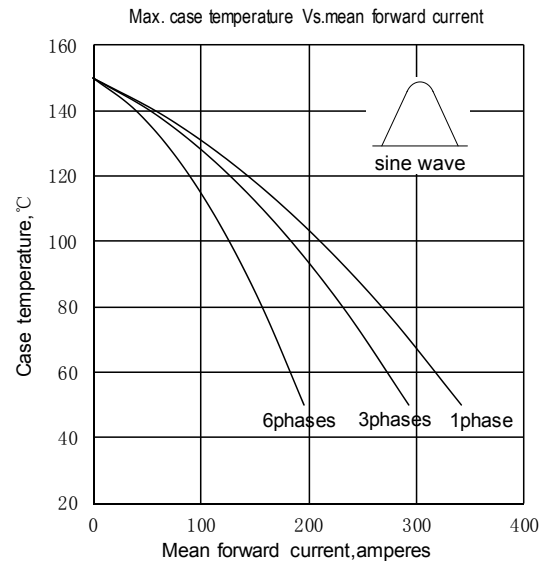

Fig.4

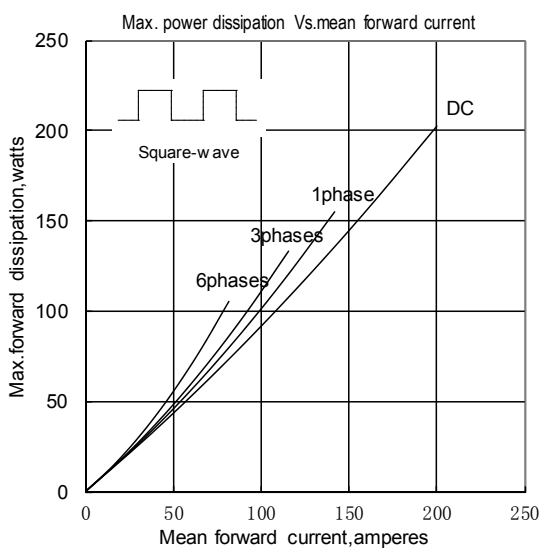

Fig.5

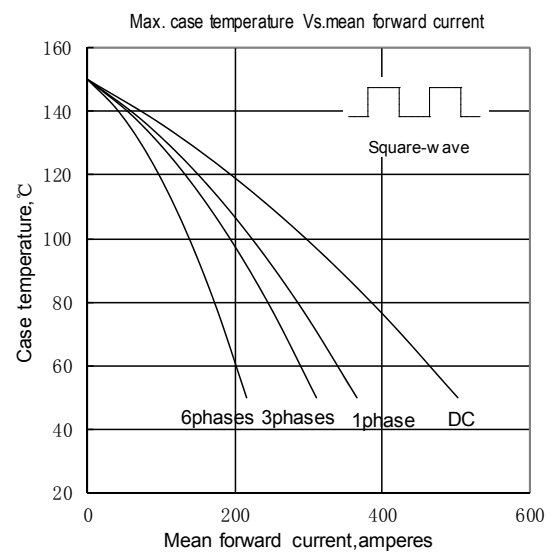

Fig.6

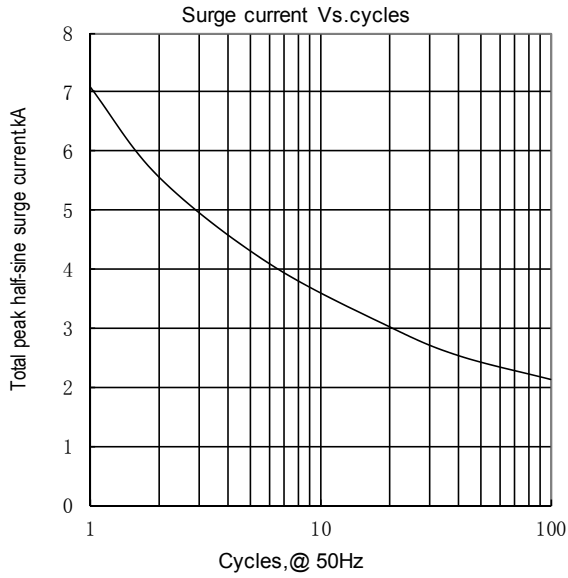

Fig.7

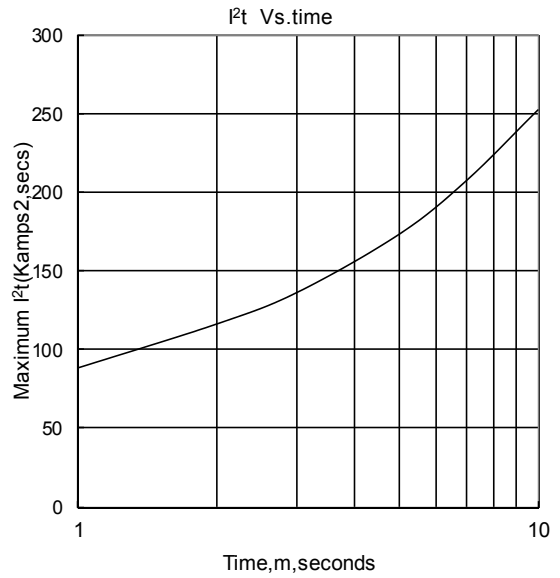
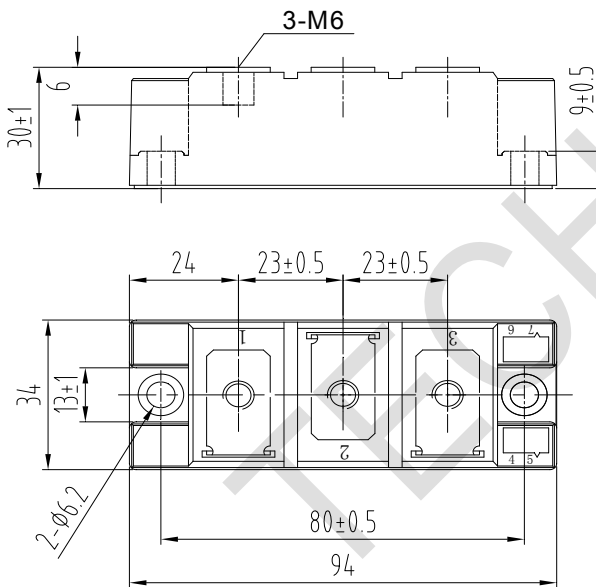

Fig.8

Outline:



MDC

MDA

MDK

MD

