



**Features:**

- Isolated mounting base 3000V~
- Pressure contact technology with Increased power cycling capability
- Space and weight saving

**Typical Applications**

- Various rectifiers
- DC supply for PWM inverter

V <sub>RSM</sub>	V <sub>RRM</sub>	Type & Outline
2100V	2000V	MDx182-20-216F3
2300V	2200V	MDx182-22-216F3
2600V	2500V	MDx182-25-216F3

SYMBOL	CHARACTERISTIC	TEST CONDITIONS	T <sub>j</sub> (°C)	VALUE			UNIT
				Min	Type	Max	
I <sub>F(AV)</sub>	Mean forward current	180° half sine wave 50Hz Single side cooled, T <sub>c</sub> =100°C	150			182	A
I <sub>F(RMS)</sub>	RMS forward current		150			286	A
I <sub>RRM</sub>	Repetitive peak current	at V <sub>RRM</sub>	150			12	mA
I <sub>FSM</sub>	Surge forward current	10ms half sine wave V <sub>R</sub> =0.6V <sub>RRM</sub>	150			6.4	kA
i <sup>2</sup> t	i <sup>2</sup> t for fusing coordination					204	A <sup>2</sup> s*10 <sup>3</sup>
V <sub>FO</sub>	Threshold voltage		150			0.85	V
r <sub>F</sub>	Forward slope resistance					1.05	mΩ
V <sub>FM</sub>	Peak forward voltage	I <sub>FM</sub> =550A	25			1.75	V
R <sub>th(j-c)</sub>	Thermal resistance Junction to case	At 180° sine Single side cooled per chip				0.20	°C /W
R <sub>th(c-h)</sub>	Thermal resistance case to heatsink	At 180° sine Single side cooled per chip				0.08	°C /W
V <sub>iso</sub>	Isolation voltage	50Hz, R.M.S, t=1min, I <sub>iso</sub> : 1mA(max)		3000			V
F <sub>m</sub>	Terminal connection torque(M6)				6.0		N·m
	Mounting torque(M6)				6.0		N·m
T <sub>stg</sub>	Stored temperature			-40		125	°C
W <sub>t</sub>	Weight				320		g
Outline	216F3						

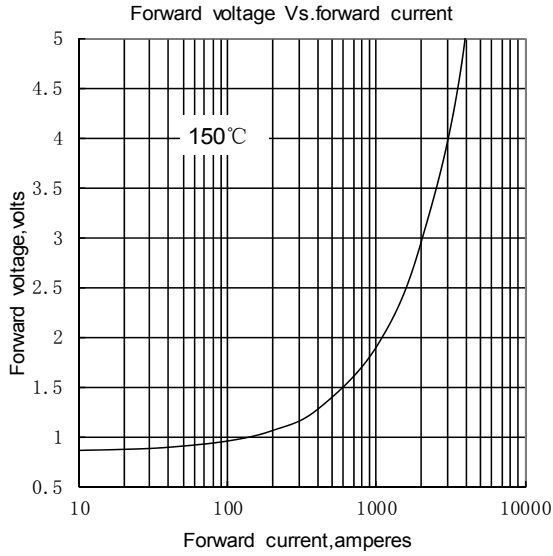

Fig.1

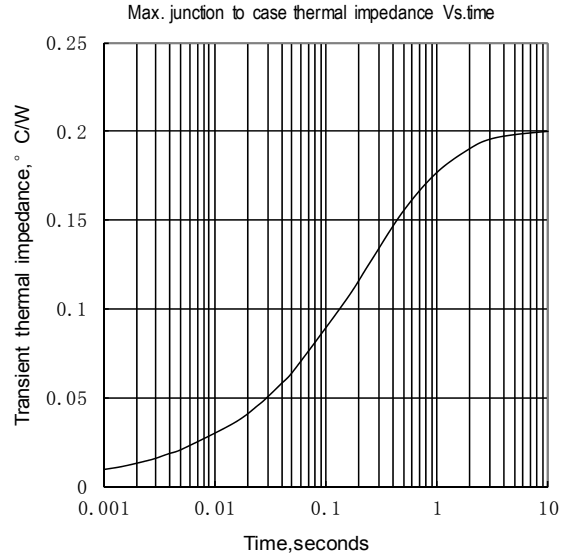

Fig.2

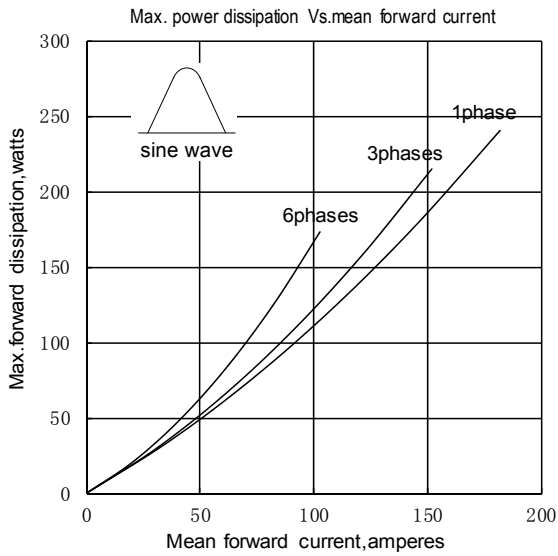

Fig.3

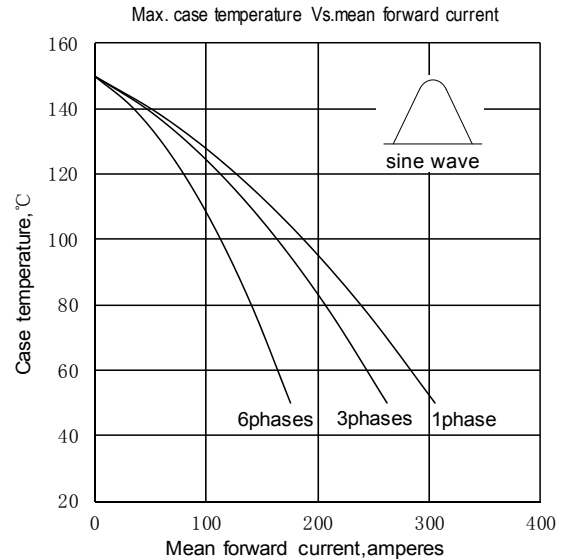

Fig.4

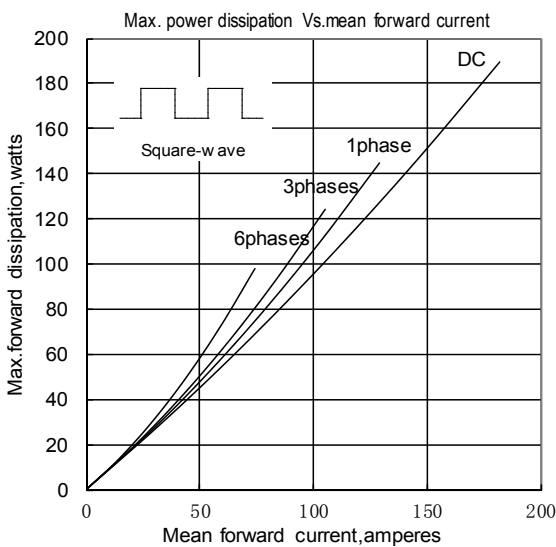

Fig.5

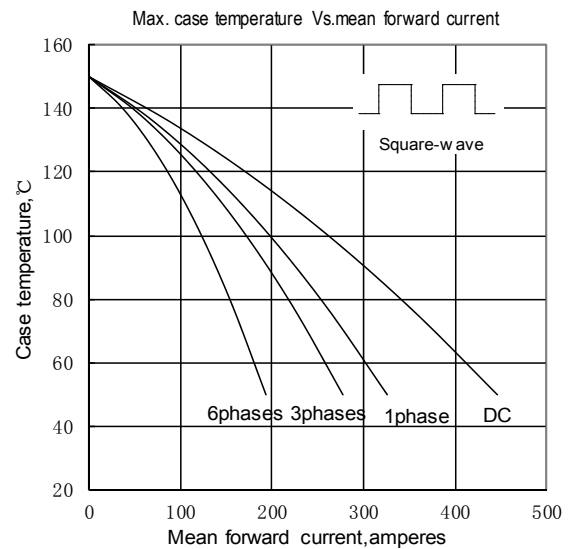

Fig.6

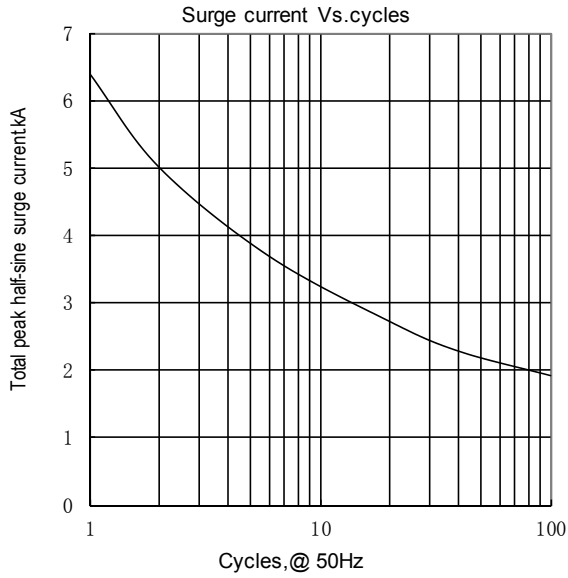

Fig.7

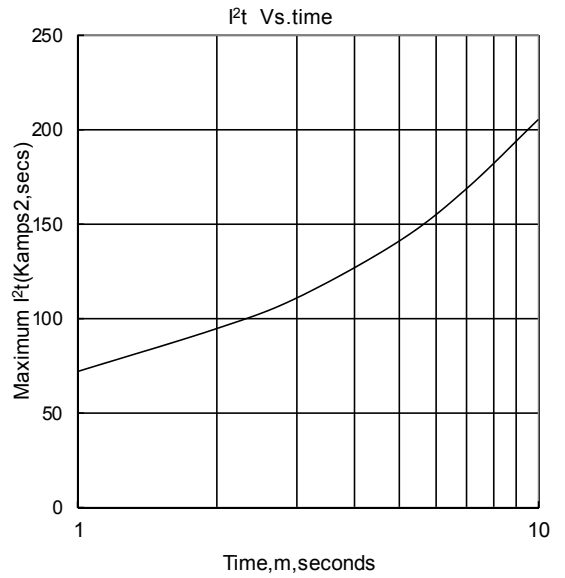
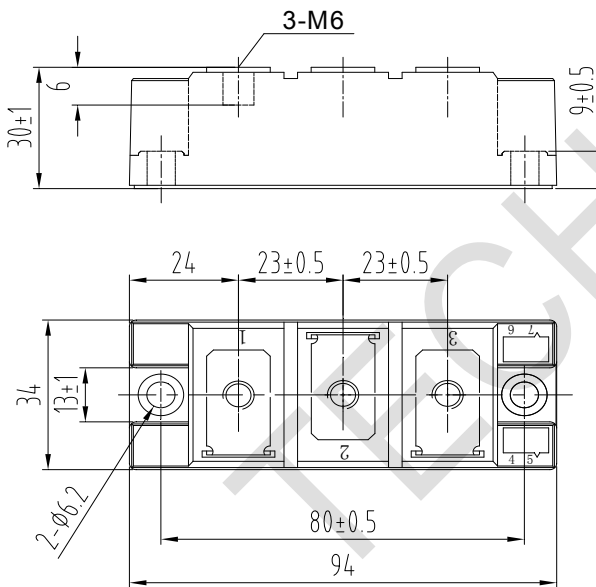
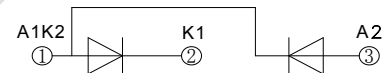

Fig.8

Outline:



MDC



MDA

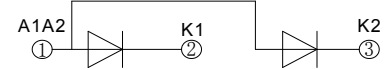

MDK

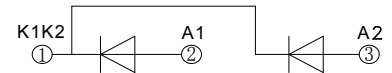

MD

