

**Features:**

- Isolated mounting base 2500V~
- Pressure contact technology with Increased power cycling capability
- Space and weight saving

Typical Applications

- Various rectifiers
- DC supply for PWM inverter

V_{RSM}	V_{RRM}	Type & Outline
900V	800V	MDx160-08-216F3
1100V	1000V	MDx160-10-216F3
1300V	1200V	MDx160-12-216F3
1500V	1400V	MDx160-14-216F3
1700V	1600V	MDx160-16-216F3
1900V	1800V	MDx160-18-216F3

SYMBOL	CHARACTERISTIC	TEST CONDITIONS	$T_j(^{\circ}\text{C})$	VALUE			UNIT
				Min	Type	Max	
$I_{F(AV)}$	Mean forward current	180° half sine wave 50Hz Single side cooled, $T_c=100^{\circ}\text{C}$	150			160	A
$I_{F(RMS)}$	RMS forward current		150			251	A
I_{RRM}	Repetitive peak current	at V_{RRM}	150			12	mA
I_{FSM}	Surge forward current	10ms half sine wave $V_R=0.6V_{RRM}$	150			4.60	kA
I^2t	I^2t for fusing coordination					106	$\text{A}^2\text{s}\cdot 10^3$
V_{FO}	Threshold voltage		150			0.80	V
r_F	Forward slope resistance					1.35	m Ω
V_{FM}	Peak forward voltage	$I_{FM}=480\text{A}$	25			1.56	V
$R_{th(j-c)}$	Thermal resistance Junction to case	At 180° sine Single side cooled per chip				0.23	$^{\circ}\text{C}/\text{W}$
$R_{th(c-h)}$	Thermal resistance case to heatsink	At 180° sine Single side cooled per chip				0.08	$^{\circ}\text{C}/\text{W}$
V_{iso}	Isolation voltage	50Hz, R.M.S, $t=1\text{min}$, $I_{iso}:1\text{mA}(\text{max})$		2500			V
F_m	Terminal connection torque(M6)				6		N·m
	Mounting torque(M6)				6		N·m
T_{stg}	Stored temperature			-40		125	$^{\circ}\text{C}$
W_t	Weight				320		g
Outline	216F3						

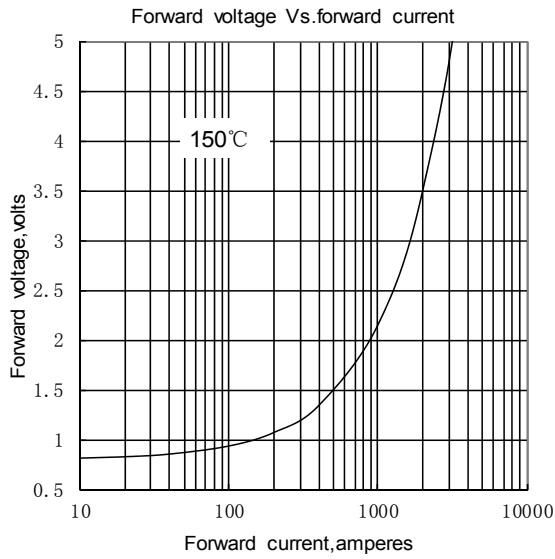

Fig.1

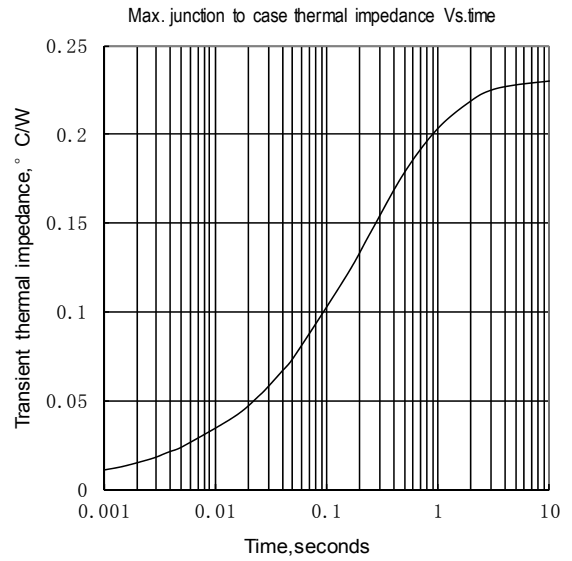

Fig.2

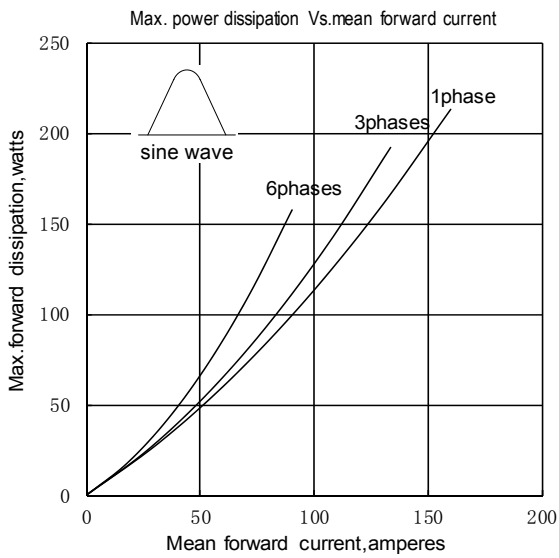

Fig.3

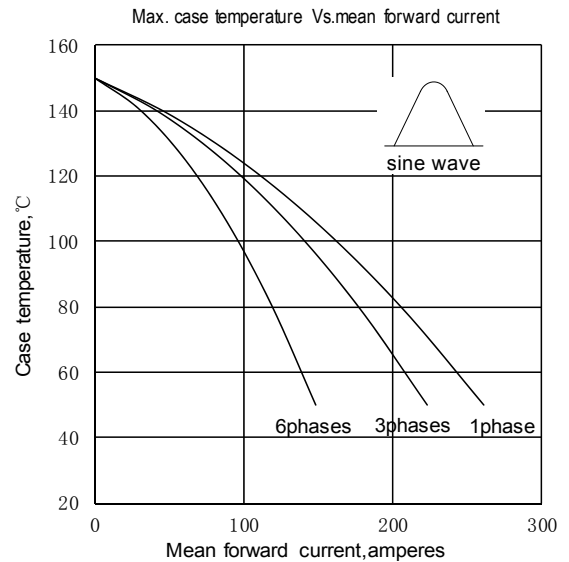

Fig.4

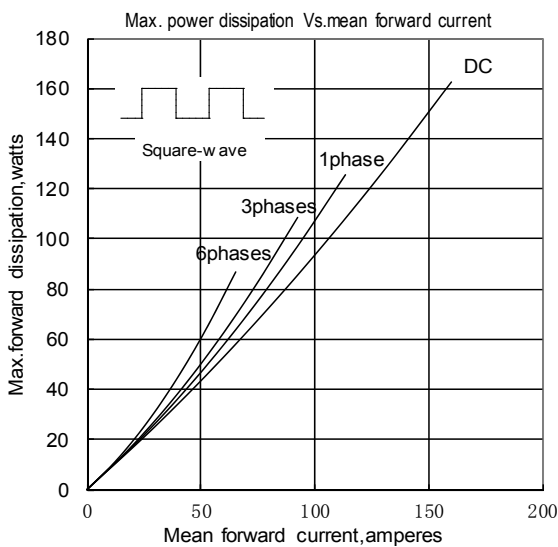

Fig.5

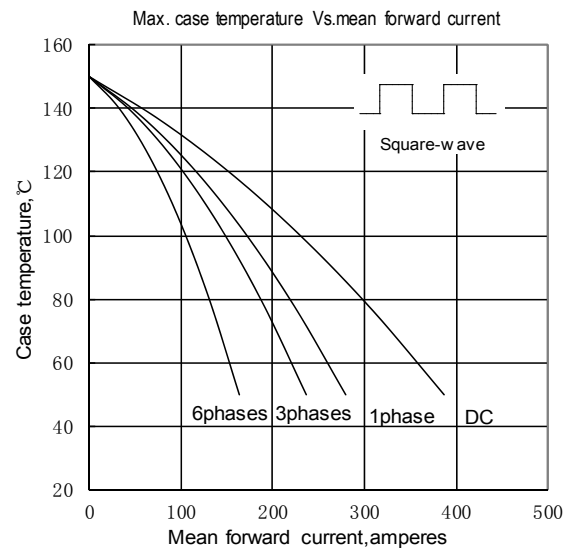

Fig.6

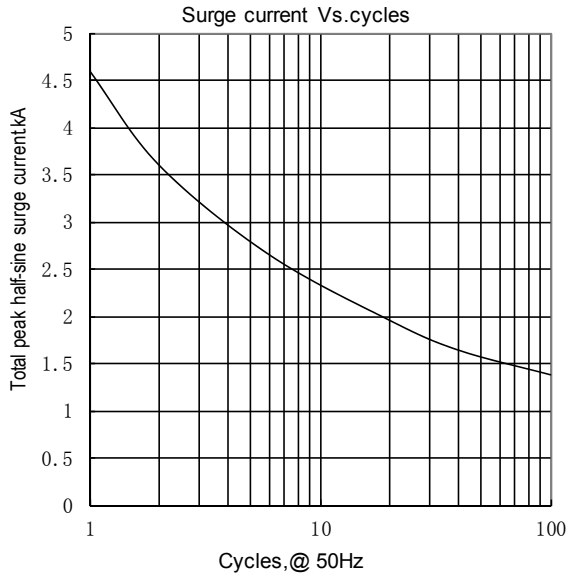

Fig.7

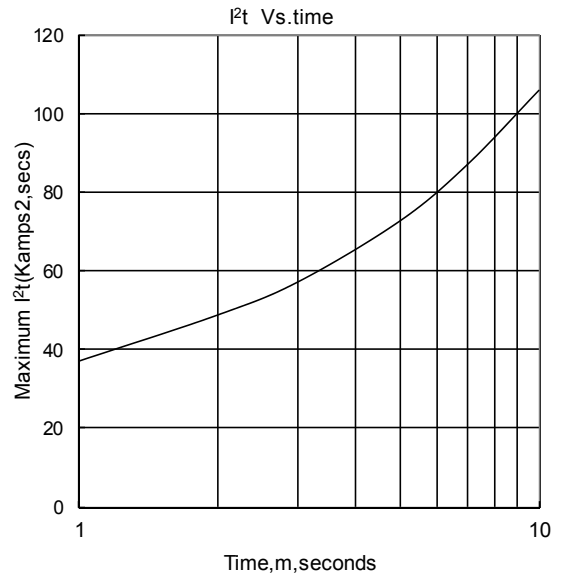
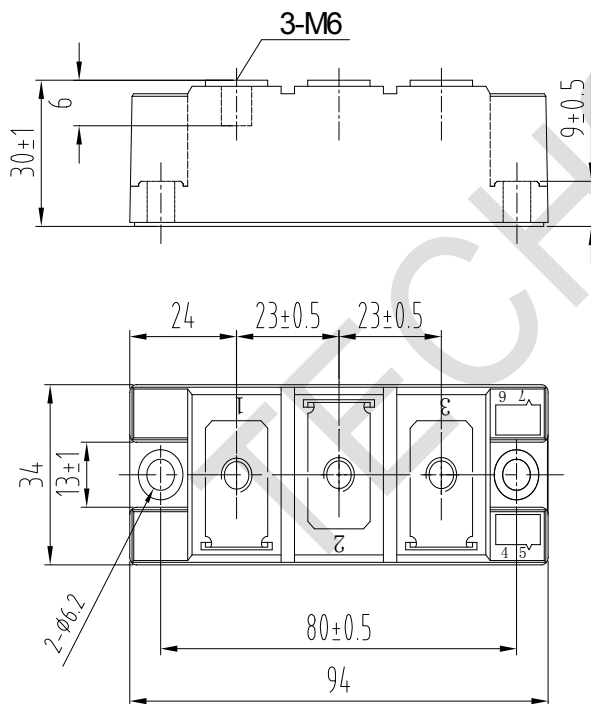
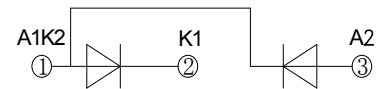

Fig.8

Outline:



MDC



MDA

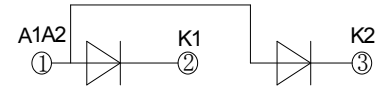

MDK

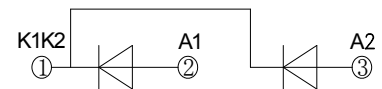

MD

